



SH-T1632

Tubular Solenoid

Unit : mm
Shown energized

PULL TYPE

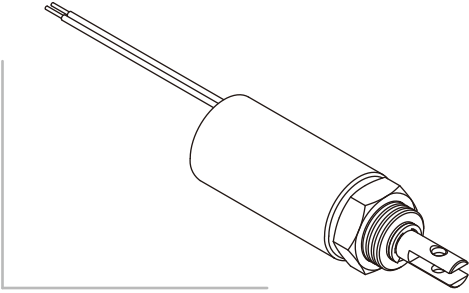

PUSH TYPE

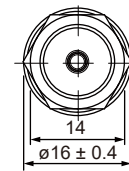
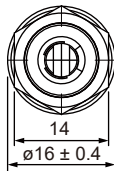
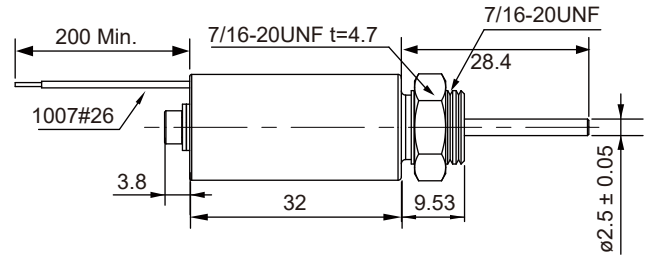
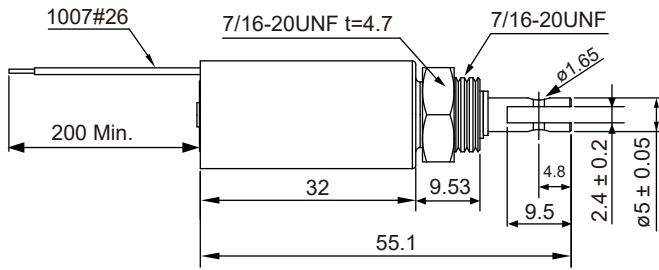
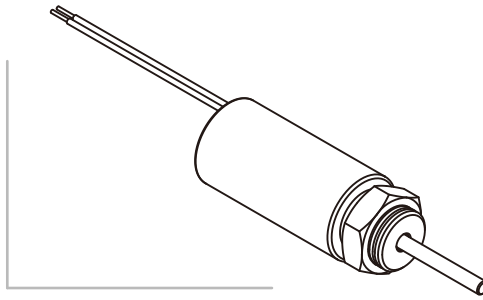

Total Weight : 47 g

DATA FORCE

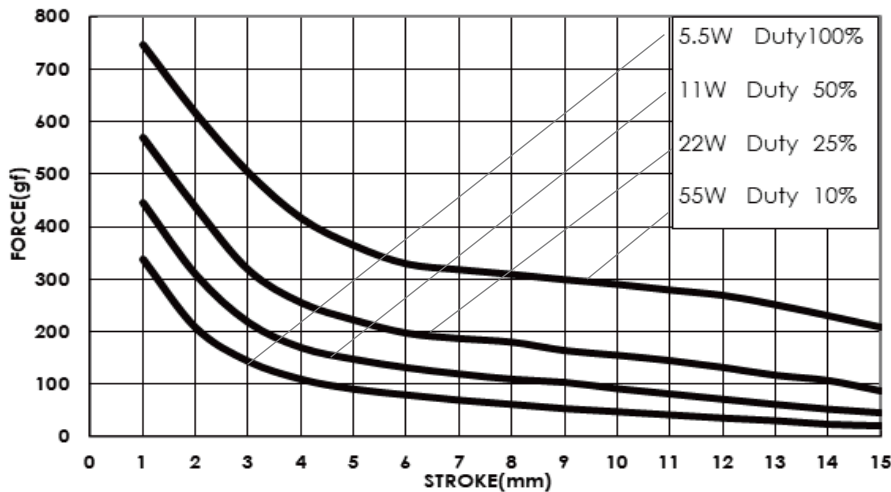

COIL DATA

Duty cycle(%)	$= \frac{\text{"ON" time}}{\text{"ON" time} + \text{"OFF" time}} \times 100\%$	Continuous (100%)	Intermittent (50%)	Intermittent (25%)	Intermittent (10%)
Watts at 20°C		5.5	11	22	55
MAX. "ON" time in seconds		∞	230	25	6
Type no.	Resistance(20°C)±10%	DC Volts			
SH-T1632S/L-06V	6.5	6	8.5	12	19
SH-T1632S/L-12V	26.2	12	17	24	38
SH-T1632S/L-24V	104.7	24	34	48	76
SH-T1632S/L-48V	419	48	68	96	152