



SH-1250

Open Frame Solenoid

Unit : mm
Shown energized

PULL TYPE

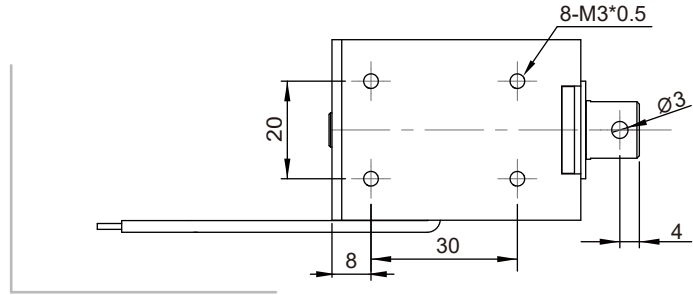
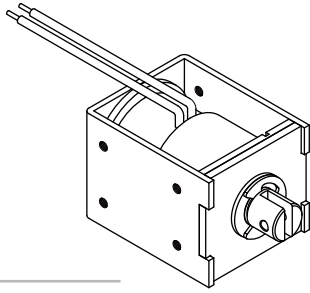

PUSH TYPE

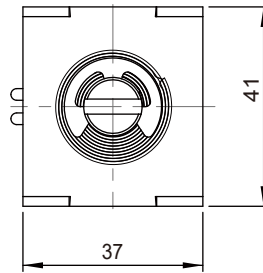
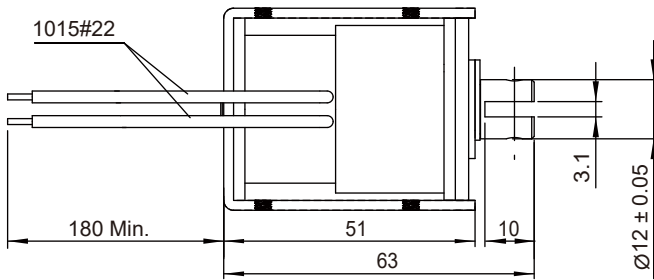
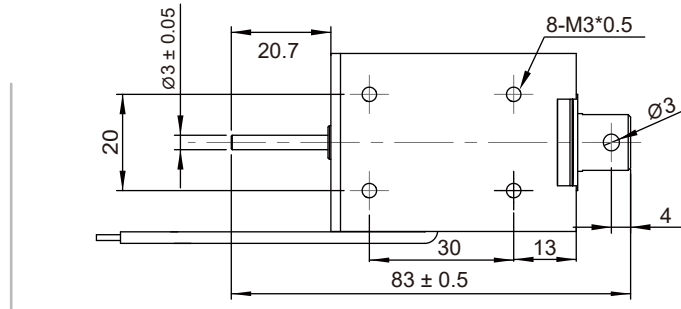
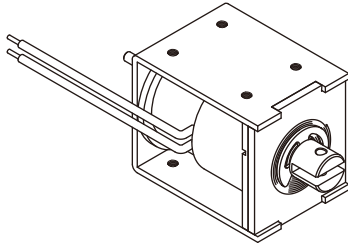

Total Weight : 315 g

DATA FORCE

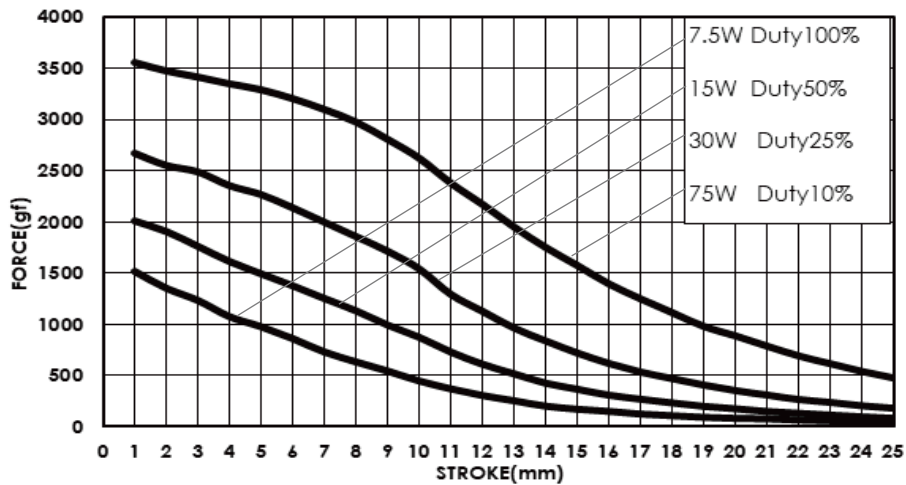

COIL DATA

Duty cycle (%)	$= \frac{\text{"ON" time}}{\text{"ON" time} + \text{"OFF" time}} \times 100\%$	Continuous (100%)	Intermittent (50%)	Intermittent (25%)	Intermittent (10%)
Watts at 20°C		7.5	15	30	75
MAX. "ON" time in seconds		∞	140	50	9
Type no.	Resistance(20°C)±10%	DC Volts			
SH-1250S/L-06V	4.8	6	8.5	12	19
SH-1250S/L-12V	19.2	12	17	24	38
SH-1250S/L-24V	76.8	24	34	48	76
SH-1250S/L-48V	307.2	48	68	96	152