



SH-1039

Open Frame Solenoid

Unit : mm
Shown energized

PULL TYPE

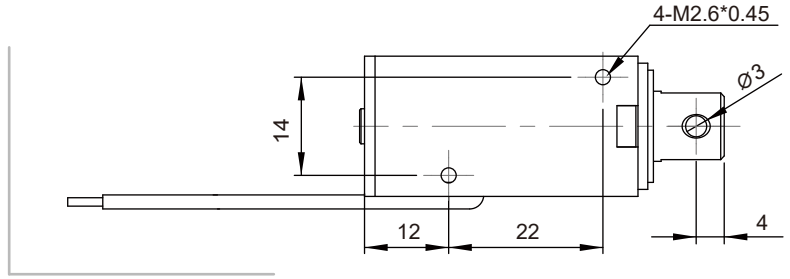
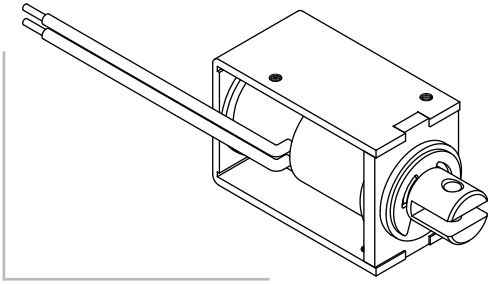

PUSH TYPE

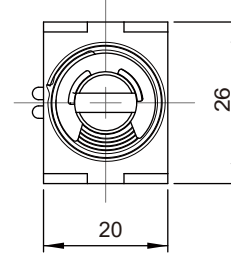
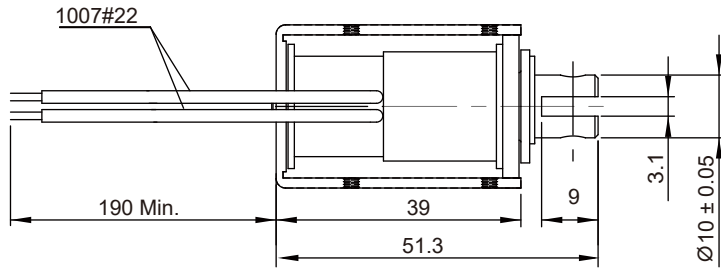
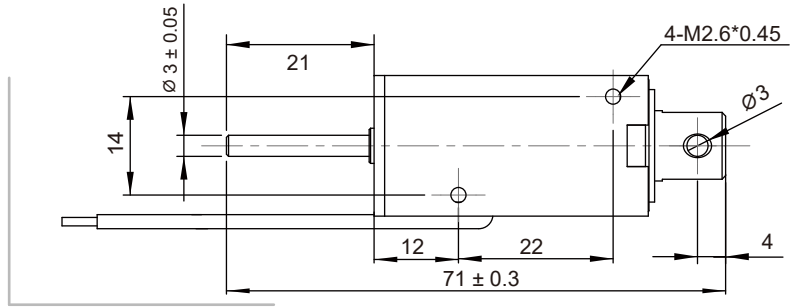
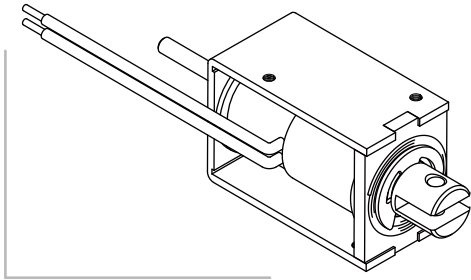

Total Weight : 110 g

DATA FORCE

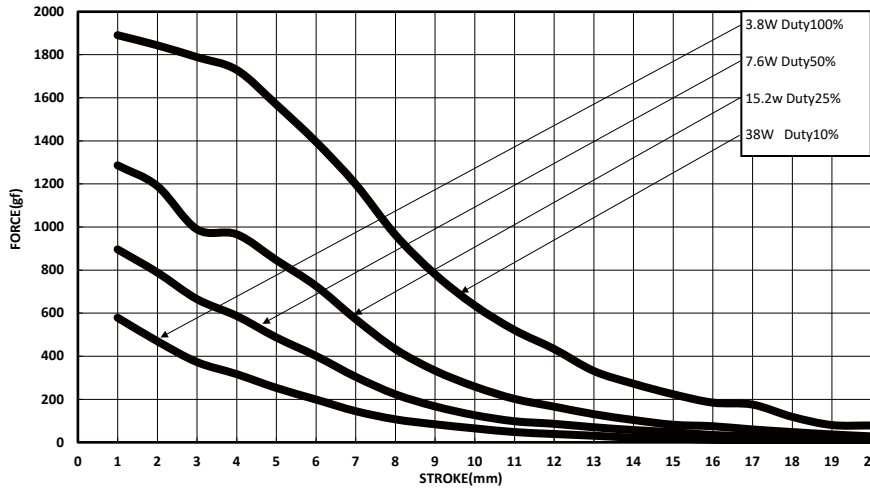

COIL DATA

Duty cycle(%)	$= \frac{\text{"ON" time}}{\text{"ON" time} + \text{"OFF" time}} \times 100\%$	Continuous (100%)	Intermittent (50%)	Intermittent (25%)	Intermittent (10%)
Watts at 20°C		3.8	7.6	15.2	38
MAX. "ON" time in seconds		∞	140	50	9
Type no.	Resistance(20°C)±10%	DC Volts			
SH-1039S/L-06V	9.5	6	8.5	12	19
SH-1039S/L-12V	38	12	17	24	38
SH-1039S/L-24V	152	24	34	48	76
SH-1039S/L-48V	606	48	68	96	152