



# SH-1037

# Open Frame Solenoid

Unit : mm  
Shown energized

## PULL TYPE

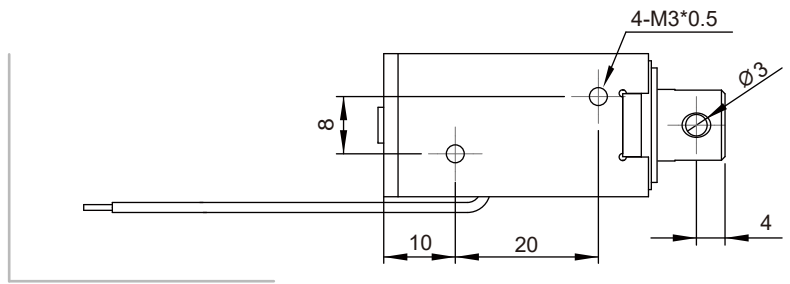
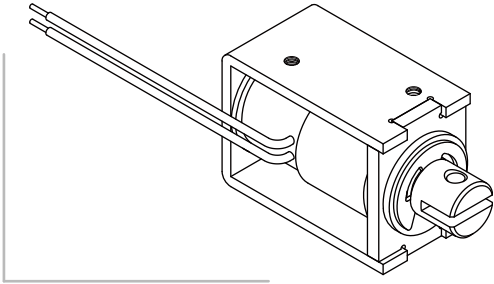

## PUSH TYPE

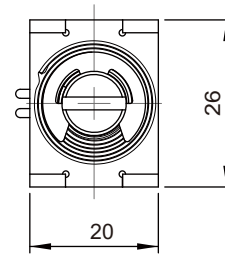
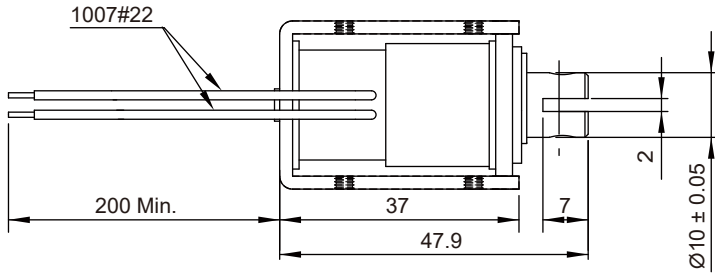
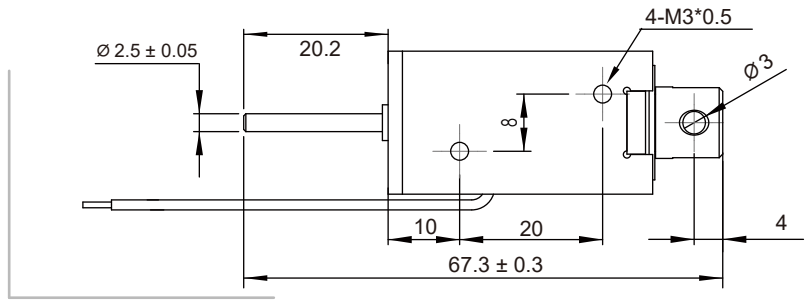
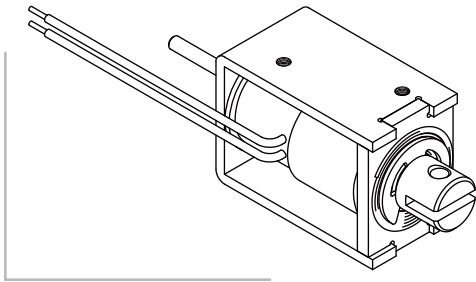

Total Weight : 96 g

## DATA FORCE

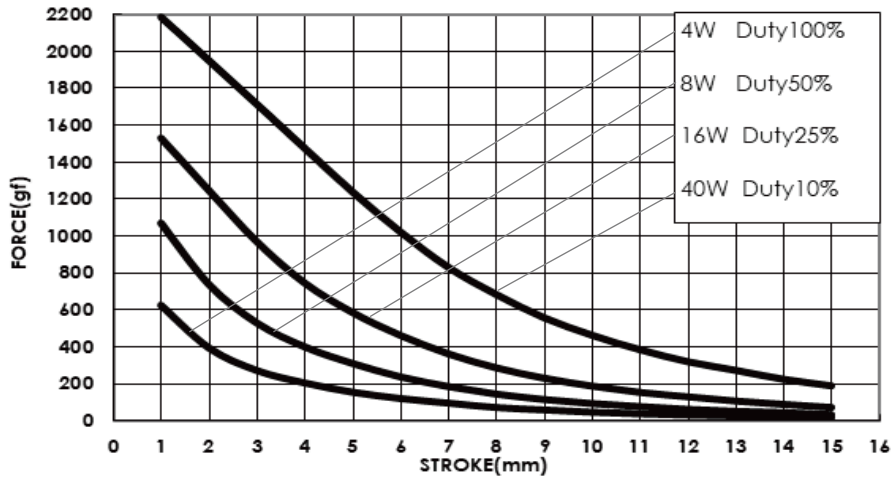

## COIL DATA

Duty cycle (%)	$= \frac{\text{"ON" time}}{\text{"ON" time} + \text{"OFF" time}} \times 100\%$	Continuous (100%)	Intermittent (50%)	Intermittent (25%)	Intermittent (10%)
Watts at 20°C		4	8	16	40
MAX. "ON" time in seconds		∞	100	36	7
Type no.	Resistance(20°C)±10%	DC Volts			
SH-1037S/L-06V	9	6	8.5	12	19
SH-1037S/L-12V	36	12	17	24	38
SH-1037S/L-24V	144	24	34	48	76
SH-1037S/L-48V	576	48	68	96	152